

Distributed by:

JAMECO[®]
ELECTRONICS

www.Jameco.com ♦ 1-800-831-4242

The content and copyrights of the attached
material are the property of its owner.

Jameco Part Number 1531559

UC1854B
UC2854A, UC2854B
UC3854A, UC3854B

SLUS329E - JUNE 1998 - REVISED AUGUST 2006

DESCRIPTION (continued)

The UC3854A/B products improve upon the UC3854 by offering a wide bandwidth, low offset current amplifier, a faster responding and improved accuracy enable comparator, a VREF GOOD comparator, UVLO threshold options (16 V/10 V for offline, 10.5 V/10 V for startup from an auxiliary 12 V regulator), lower startup supply current, and an enhanced multiply/divide circuit. New features like the amplifier output clamps, improved amplifier current sinking capability, and low offset VAC pin reduce the external component count while improving performance. Improved common mode input range of the multiplier output/current amplifier input allow the designer greater flexibility in choosing a method for current sensing. Unlike its predecessor, R_{SET} controls only oscillator charging current and has no effect on clamping the maximum multiplier output current. This current is now clamped to a maximum of 2 × I_{AC} at all times which simplifies the design process and provides foldback power limiting during brownout and extreme low line conditions.



These devices have limited built-in ESD protection. The leads should be shorted together or the device placed in conductive foam during storage or handling to prevent electrostatic damage to the MOS gates.

ABSOLUTE MAXIMUM RATINGS

over operating free-air temperature range unless otherwise noted⁽¹⁾

		UCX854A, UCX854B	UNIT
Supply voltage, V _{CC}		22	V
GTDRV current, I _{GTDRV}	Continuous	0.5	A
GTDRV Current, I _{GTDRV}	50% duty cycle	1.5	A
Input voltage	VSENSE, VRMS, ISENSE MOUT	11	V
	PKLMT	5	V
Input current	RSET, IAC, PKLMT, ENA	10	mA
Power dissipation		1	W
Junction temperature, T _J		-55 to 150	°C
Storage temperature, T _{stg}		-65 to 150	
Lead temperature, T _{sol} , 1.6 mm (1/16 inch) from case for 10 seconds		300	

⁽¹⁾ Stresses beyond those listed under "absolute maximum ratings" may cause permanent damage to the device. These are stress ratings only, and functional operation of the device at these or any other conditions beyond those indicated under "recommended operating conditions" is not implied. Exposure to absolute-maximum-rated conditions for extended periods may affect device reliability. All voltages are with respect to GND. Currents are positive into and negative out of, the specified terminal. ENA input is internally clamped to approximately 10 V.

RECOMMENDED OPERATING CONDITIONS

		MIN	MAX	UNIT
Supply voltage, V _{CC}		10	20	V
Operating junction temperature, T _J	UC1854X	-55	125	°C
	UC2854X	-40	85	
	UC3854X	0	70	

PACKAGE DESCRIPTION

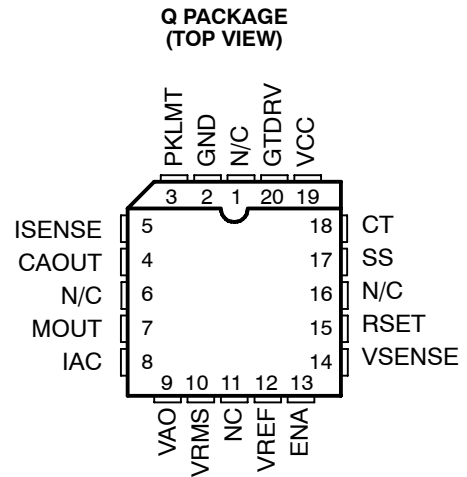
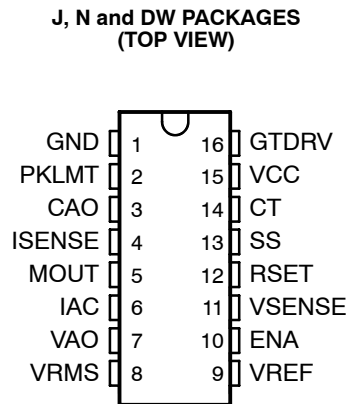

N/C - No connection

ORDERING INFORMATION

T _A	UVLO TURN-ON (V)	UVLO TURN-OFF (V)	PART NUMBERS			
			CDIP-16 (J)	PDIP-16 (N)	SOIC-16 (DW)	PLCC-20 (Q)
-55°C to 125°C	16	10	-	-	-	-
	10.5	10	UC1854BJ	-	-	-
-40°C to 85°C	16	10	UC2854AJ	UC2854AN	UC2854ADW	UC2854AQ
	10.5	10	UC2854BJ	UC2854BN	UC2854BDW	UC2854BQ
0°C to 70°C	16	10	-	UC3854AN	UC3854ADW	-
	10.5	10	-	UC3854BN	UC3854BDW	-

(1) The DW and Q packages are available taped and reeled. Add TR suffix to device type (e.g. UC2854ADWTR) to order quantities of 2,000 devices per reel for the DW package and 1,000 devices per reel for the Q package.

THERMAL RESISTANCE

RESISTANCES	PACKAGED DEVICES			
	CDIP-16 (J)	PDIP-16 (N)	SOP-16 (DW)	PLCC-20 (Q)
θ_{JC} (°C/W)	28 ⁽²⁾	45	27	34
θ_{JA} (°C/W)	80-120	90 ⁽³⁾	50-130 ⁽³⁾	43-75 ⁽³⁾

(2) θ_{JC} data values stated are derived from MIL-STD-1835B which states "the baseline values shown are worst case (mean +2s) for a 60 x 60 mil microcircuit device silicon die and applicable for devices with die sizes up to 14,400 square mils. For device die sizes greater than 14,400 square mils use the following values, dual-in-line, 11°C/W; flat pack and pin grid array, 10°C/W.

(3) θ_{JA} (junction-to-ambient) applies to devices mounted to five square inch FR4 PC board with one ounce copper where noted. When resistance range is given, lower values are for five square inch aluminum PC board. Test PWB is 0.062 inches thick and typically uses 0.635 mm trace widths for power packages and 1.3 mm trace widths for non-power packages with a 100 x 100 mil probe land are at the end of each trace.

UC1854B
UC2854A, UC2854B
UC3854A, UC3854B

SLUS329E - JUNE 1998 - REVISED AUGUST 2006

ELECTRICAL CHARACTERISTICS

$V_{CC} = 18\text{ V}$, $R_T = 8.2\text{ k}\Omega$, $C_T = 1.5\text{ nF}$, $V_{PKLMT} = 1\text{ V}$, $V_{VRMS} = 1.5\text{ V}$, $I_{IAC} = 100\text{ }\mu\text{A}$, $I_{ISENSE} = 0\text{ V}$, $V_{CAO} = 3.5\text{ V}$, $V_{VAO} = 5\text{ V}$, $V_{VSENSE} = 3\text{ V}$, $-40^\circ\text{C} < T_A < 85^\circ\text{C}$ for the UC2854A and UC2854B, and $0^\circ\text{C} < T_A < 70^\circ\text{C}$ for the UC3854A and UC3854B, and $T_A = T_J$ (unless otherwise noted)

PARAMETER		TEST CONDITIONS	MIN	TYP	MAX	UNIT
OVERALL						
Supply current, off		$CAO = 0\text{ V}$, $VAO = 0\text{ V}$, $V_{CC} = V_{UVLO} - 0.3\text{ V}$		250	400	μA
Supply current, on				12	18	mA
V_{CC} turn-on threshold voltage	UCx854A		15.0	16.0	17.5	V
	UCx854B		8.0	10.5	11.2	
V_{CC} turn-off threshold voltage	UCx854A		9	10	12	
	UCx854B		7.8	10.3	11.0	
V_{CC} hysteresis	UCx854A		5	6	7	
	UCx854B		0.10	0.22	0.50	
V_{CC} clamp	$I_{VCC} = I_{VCC(on)} + 5\text{ mA}$		18	20	22	
VOLTAGE AMPLIFIER						
Input voltage			2.9	3.0	3.1	V
V_{SENSE} bias current			-500	-25	500	nA
Open loop gain		$2\text{ V} \leq V_{OUT} \leq 5\text{ V}$	70	100		dB
V_{OH}	High-level output voltage	$I_{LOAD} = -500\text{ }\mu\text{A}$		6		V
V_{OL}	Low-level output voltage	$I_{LOAD} = 500\text{ }\mu\text{A}$		0.3	0.5	
I_{SC}	Output short-circuit current	$V_{OUT} = 0\text{ V}$		1.5	3.5	mA
Gain bandwidth product ⁽¹⁾		$f_{IN} = 100\text{ kHz}$, 10 mV_{P-P}		1		MHz
CURRENT AMPLIFIER						
Input offset voltage	$V_{CM} = 0\text{ V}$, $T_A = 25^\circ\text{C}$		-4		0	mV
	$V_{CM} = 0\text{ V}$, overtemperature		-5.5		0	
Input bias current, I_{SENSE}		$V_{CM} = 0\text{ V}$	-500		500	nA
Open loop gain		$2\text{ V} \leq V_{OUT} \leq 6\text{ V}$	80	110		dB
V_{OH}	High-level output voltage	$I_{LOAD} = -500\text{ }\mu\text{A}$		8		V
V_{OL}	Low-level output voltage	$I_{LOAD} = 500\text{ }\mu\text{A}$		0.3	0.5	
I_{SC}	Output short-circuit current	$V_{OUT} = 0\text{ V}$		1.5	3.5	mA
CMRR	Common mode rejection range		-0.3		5.0	V
Gain bandwidth product ⁽¹⁾		$f_{IN} = 100\text{ kHz}$, 10 mV_{P-P}	3	5		MHz
REFERENCE						
Output voltage	$I_{REF} = 0\text{ mA}$, $T_A = 25^\circ\text{C}$		7.4	7.5	7.6	V
	$I_{REF} = 0\text{ mA}$		7.35	7.50	7.65	
Load regulation		$1\text{ mA} \leq I_{REF} \leq 10\text{ mA}$	0	8	20	mV
Line regulation		$12\text{ V} \leq V_{CC} \leq 18\text{ V}$	0	14	25	
I_{SC}	Short circuit current	$V_{REF} = 0\text{ V}$	25	35	60	mA

(1) Ensured by design. Not production tested.

(2) Gain constant. (K) =
$$\frac{I_{IAC} \times (V_{VAO} - 1.5\text{ V})}{(V_{VRMS})^2 \times I_{MOUT}}$$

ELECTRICAL CHARACTERISTICS

$V_{CC} = 18\text{ V}$, $R_T = 8.2\text{ k}\Omega$, $C_T = 1.5\text{ nF}$, $V_{PKLMT} = 1\text{ V}$, $V_{VRMS} = 1.5\text{ V}$, $I_{IAC} = 100\text{ }\mu\text{A}$, $I_{ISENSE} = 0\text{ V}$, $V_{CAO} = 3.5\text{ V}$, $V_{VAO} = 5\text{ V}$, $V_{VSENSE} = 3\text{ V}$, $-40^\circ\text{C} < T_A < 85^\circ\text{C}$ for the UC2854A and UC2854B, and $0^\circ\text{C} < T_A < 70^\circ\text{C}$ for the UC3854A and UC3854B, and $T_A = T_J$ (unless otherwise noted)

PARAMETER	TEST CONDITIONS	MIN	TYP	MAX	UNIT
OSCILLATOR					
Initial accuracy	$T_A = 25^\circ\text{C}$	85	100	115	kHz
Voltage stability	$12\text{ V} \leq V_{CC} \leq 18\text{ V}$	1%			
Total variation	Line, temperature	80		120	kHz
Ramp amplitude (peak-to-peak)		4.9		5.9	V
Ramp valley voltage		0.8		1.3	
ENABLE/SOFT-START/CURRENT LIMIT					
Enable threshold voltage		2.35	2.55	2.80	V
Enable hysteresis	$V_{FAULT} = 2.5\text{ V}$		500	600	mV
Enable input bias current	$V_{ENA} = 0\text{ V}$		-2	-5	μA
Propagation delay to disable time ⁽¹⁾	Enable overdrive = 100 mV		300		ns
Soft-start charge current	$V_{SS} = 2.5\text{ V}$	10	14	24	μA
Peak limit offset voltage		-15		15	mV
Peak limit input current	$V_{PKLMT} = -0.1\text{ V}$	-200	-100		μA
Peak limit propagation delay time ⁽¹⁾			150		ns
MULTIPLIER					
Output current, I_{AC} limited	$I_{AC} = 100\text{ }\mu\text{A}$, $V_{RMS} = 1\text{ V}$, $R_{SET} = 10\text{ k}\Omega$	-220	-200	-170	μA
Output current, zero	$I_{AC} = 0\text{ }\mu\text{A}$, $R_{SET} = 10\text{ k}\Omega$	-2.0	-0.2	2.0	
Output current, power limited	$V_{RMS} = 1.5\text{ V}$, $V_a = 6\text{ V}$	-230	-200	-170	μA
Output current	$V_{RMS} = 1.5\text{ V}$, $V_a = 2\text{ V}$	-22			
	$V_{RMS} = 1.5\text{ V}$, $V_a = 5\text{ V}$	-156			
	$V_{RMS} = 5\text{ V}$, $V_a = 2\text{ V}$	-2			
	$V_{RMS} = 5\text{ V}$, $V_a = 5\text{ V}$	-14			
Gain constant ⁽²⁾	$V_{RMS} = 1.5\text{ V}$, $V_a = 6\text{ V}$, $T_A = 25^\circ\text{C}$	-1.1	-1.0	-0.9	A/A
GATE DRIVER					
V_{OH} High-level output voltage	$I_{OUT} = -200\text{ mA}$, $V_{CC} = 15\text{ V}$	12.0	12.8		V
V_{OL} Low-level output voltage	$I_{OUT} = 200\text{ mA}$		1.0	2.2	
	$I_{OUT} = 10\text{ mA}$		300	500	mV
Low-level UVLO voltage	$I_{OUT} = 50\text{ mA}$, $V_{CC} = 0\text{ V}$		0.9	1.5	V
Output rise time ⁽¹⁾	$C_{LOAD} = 1\text{ nF}$		35		ns
Output fall time ⁽¹⁾	$C_{LOAD} = 1\text{ nF}$		35		
Output peak current ⁽¹⁾	$C_{LOAD} = 10\text{ nF}$		1.0		A

(1) Ensured by design. Not production tested.

(2) Gain constant. $(K) = \frac{I_{IAC} \times (V_{VAO} - 1.5\text{ V})}{[(V_{VRMS})^2 \times I_{MOUT}]}$

UC1854B
UC2854A, UC2854B
UC3854A, UC3854B

SLUS329E - JUNE 1998 - REVISED AUGUST 2006

TERMINAL FUNCTIONS

TERMINAL NAME	PACKAGES		I/O	DESCRIPTION
	J/N/DW	Q/L		
CAO	3	4	O	Output of the wide bandwidth current amplifier and one of the inputs to the PWM duty-cycle comparator. The output signal generated by this amplifier commands the PWM to force the correct input current. The output can swing from 0.1 V to 7.5 V.
CT	14	18	I	Capacitor from CT to GND sets the PWM oscillator frequency
ENA	10	13	I	A nominal voltage above 2.65 V on this pin allows the device to begin operating. Once operating, the device shuts off if this pin goes below 2.15 V nominal.
GND	1	2	-	All bypass and timing capacitors connected to GND should have leads as short and direct as possible. All voltages are measured with respect GND.
GTDRV	16	20	O	Output of the PWM is a 1.5-A peak totem-pole MOSFET gate driver on GTDRV. Use a series gate resistor of at least 5 Ω to prevent interaction between the gate impedance and the GTDRV output driver that might cause the GTDRV output to overshoot excessively. Some overshoot of the GTDRV output is always expected when driving a capacitive load.
IAC	6	8	I	Current input to the multiplier, proportional to the instantaneous line voltage. This input to the analog multiplier is a current. The multiplier is tailored for very low distortion from this current input (IAC) to MOUT, so this is the only multiplier input that should be used for sensing instantaneous line voltage.
ISENSE	4	5	I	Switch current sensing input. This is the inverting input to the current amplifier. This input and the non-inverting input MOUT remain functional down to and below GND. Care should be taken to avoid taking these inputs below -0.5V, because they are protected with diodes to GND.
MOUT	5	7	I/O	Multiplier output and current sense plus. The output of the analog multiplier and the non-inverting input of the current amplifier are connected together at MOUT. The cautions about taking ISENSE below -0.5V also apply to MOUT. As the multiplier output is a current, this is a high-impedance input similar to ISENSE, so the current amplifier can be configured as a differential amplifier to reject GND noise. $I_{MOUT} \leq 2 \times I_{AC}$
PKLMT	2	3	I	Peak limit. The threshold for PKLMT is 0.0 V. Connect this input to the negative voltage on the current sense resistor. Use a resistor to REF to offset the negative current sense signal up to GND.
RSET	12	15	I	Oscillator charging current and multiplier limit set. A resistor from RSET to ground programs oscillator charging current.
SS	13	17	I	Soft-start. SS remains at GND as long as the device is disabled or V _{CC} is too low. SS pulls up to over 3 V by an internal 14-μA current source when both V _{CC} becomes valid and the device is enabled. SS acts as the reference input to the voltage amplifier if SS is below VREF. With a large capacitor from SS to GND, the reference to the voltage regulating amplifier rises slowly, and increase the PWM duty cycle slowly. In the event of a disable command or a supply dropout, SS will quickly discharge to ground and disable the PWM.
VAO	7	9	I	Voltage amplifier output
VCC	15	19	I	Positive supply rail
VREF	9	12	O	Used to set the peak limit point and as an internal reference for various device functions. This voltage must be present for the device to operate.
VRMS	8	10	I	One of the inputs into the multiplier. This pin provides the input RMS voltage to the multiplier circuitry.
VSENSE	11	14	I	This pin provides the feedback from the output. This input goes into the voltage error amplifier and the output of the error amplifier is another of the inputs into the multiplier circuit.

FUNCTIONAL DESCRIPTION

The UC3854A and UC3854B family of products are designed as pin compatible upgrades to the industry standard UC3854 active power factor correction circuits. The circuit enhancements allow the user to eliminate in most cases several external components currently required to successfully apply the UC3854. In addition, linearity improvements to the multiply, square and divide circuitry optimizes overall system performance. Detailed descriptions of the circuit enhancements are provided below. For in-depth design applications reference data refer to the application notes, *UC3854 Controlled Power Factor Correction Circuit Design* (SLUA144) and *UC3854A and UC3854B Advanced Power Factor Correction Control ICs* (SLUA177).

Multiply/Square and Divide

The UC3854A/B multiplier design maintains the same gain constant ($K = \frac{-1}{V}$) as the UC3854. The relationship between the inputs and output current is given as:

$$I_{MOUT} = I_{IAC} \times \frac{(V_{VAO} - 1.5 \text{ V})}{K \times (V_{VRMS})^2} \quad (1)$$

This is nearly the same as the UC3854, but circuit differences have improved the performance and application.

The first difference is with the IAC input. The UC3854A/B regulated this pin voltage to the nominal 500 mV over the full operating temperature range, rather than the 6.0 V used on the UC3854. The low offset voltage eliminates the need for a line zero crossing compensating resistor to VREF from IAC that UC3854 designs require. The maximum current at high line into IAC should be limited to 250 μ A for best performance.

Therefore, if $V_{VAC(max)} = 270 \text{ V}$,

$$R_{IAC} = \frac{270 \times 1.414}{250 \mu\text{A}} = 1.53 \text{ M}\Omega \quad (2)$$

The V_{RMS} pin linear operating range is improved with the UC3854A/B as well. The input range for VRMS extends from 0 V to 5.5 V. Since the UC3854A squaring circuit employs an analog multiplier, rather than a linear approximation, accuracy is improved, and discontinuities are eliminated. The external divider network connected to VRMS should produce 1.5 V at low line (85 VAC). This puts 4.77 V on VRMS at high line (270 VAC) which is well within its operating range.

The voltage amplifier output forms the third input to the multiplier and is internally clamped to 6.0 V. This eliminated an external zener clamp often used in UC3854 designs. The offset voltage at this input to the multiplier has been raised on the UC3854A/B to 1.5 V.

The multiplier output pin, which is also common to the current amplifier non-inverting input, has a -0.3 V to 5.0 V output range, compared to the -0.3 V to 2.5 V range of the UC3854. This improvement allows the UC3854A/B to be used in applications where the current sense signal amplitude is very large.

Voltage Amplifier

The UC3854A/B voltage amplifier design is essentially similar to the UC3854 with two exceptions. The first is with the internal connection. The lower voltage reduces the amount of charge on the compensation capacitors, which provides improved recovery from large signal events, such as line dropouts, or power interruption. It also minimizes the dc current flowing through the feedback. The output of the voltage amplifier is also changes. In addition to a 6.0 V temperature compensated clamp, the output short circuit current has been lowered to 2 mA typical, and an active pull down has replaced the passive pull down of the UC3854.

Current Amplifier

The current amplifier for an average current PFC controller needs a low offset voltage in order to minimize AC line current distortion. With this in mind, the UC3854A/B current amplifier has improved the input offset voltage from ± 4 mV to 0 V to ± 3 mV. The negative offset of the UC3854A/B guarantees that the PWM circuit will not drive the MOSFET if the current command is zero (both current amplifier inputs zero.) Previous designs required an external offset cancellation network to implement this key feature. The bandwidth of the current amplifier has been improved as well to 5 MHz typical. While this is not generally an issue at 50 Hz or 60 Hz inputs, it is essential for 400 Hz input avionics applications

Miscellaneous

Several other important enhancements have been implemented in the UC3854A/B. A V_{CC} supply voltage clamp at 20 V allows the controller to be current fed if desired. The lower startup supply current (250 μ A typical), substantially reduces the power requirements of an offline startup resistor. The 10.5 V/10 V UVLO option (UC3854B) enables the controller to be powered off of an auxiliary 12 V supply.

The VREF GOOD comparator guarantees that the MOSFET driver output remains low if the supply of the 7.5 V reference are not yet up. This improvement eliminates the need for external Schottky diodes on the PKLMT and Mult Out pins that some UC3854 designs require. The propagation delay of the disable feature has been improved to 300 ns typical. This delay was proportional to the size of the VREF capacitor on the UC3854, and is typically several orders of magnitude slower.

TYPICAL CHARACTERISTICS

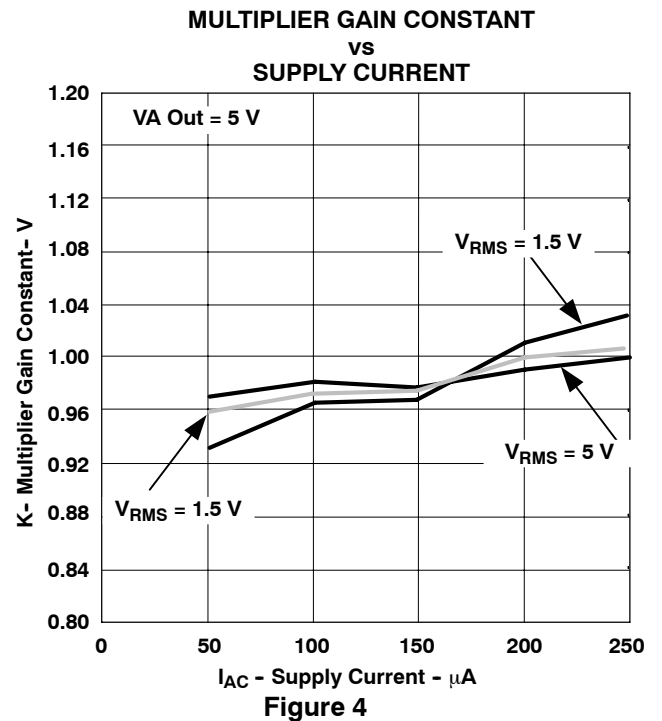
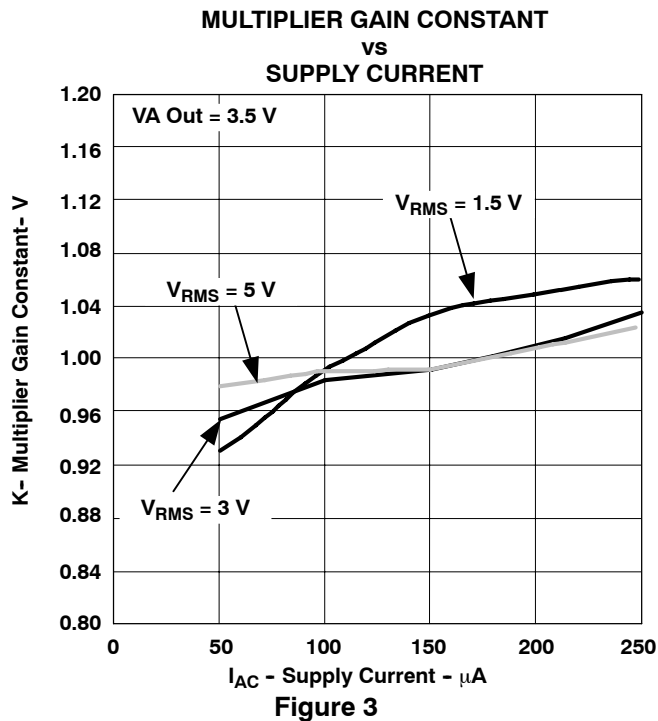
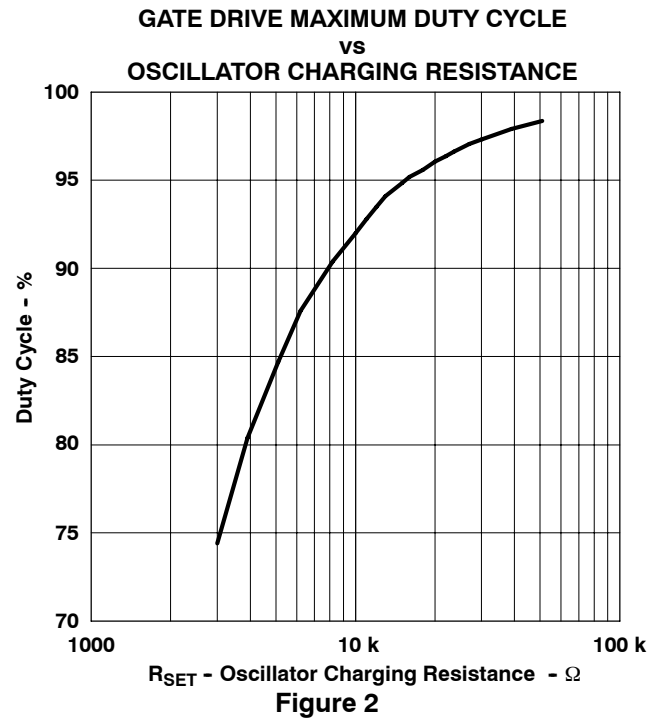
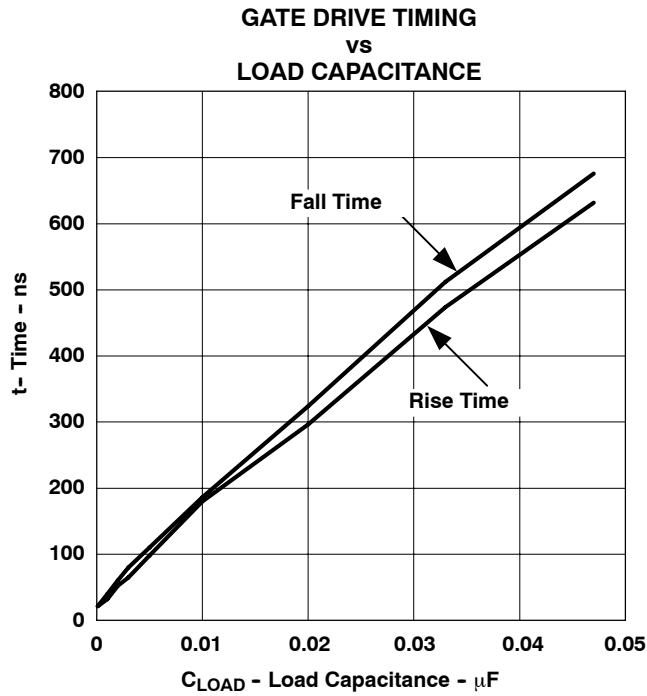

CURRENT AMPLIFIER GAIN
 vs
 FREQUENCY

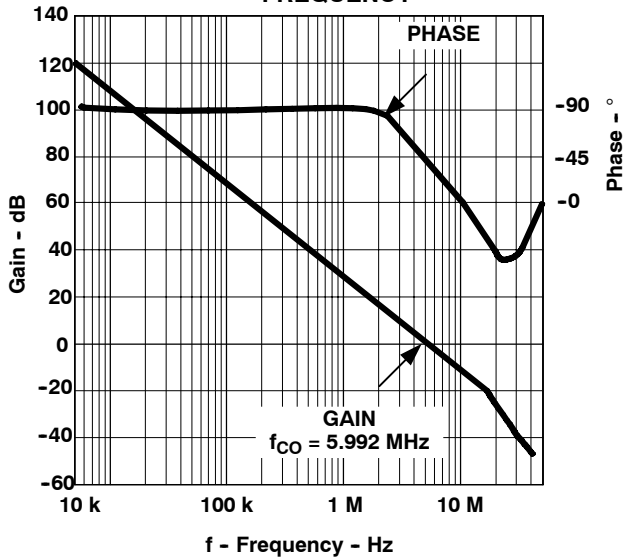

Figure 5

VOLTAGE AMPLIFIER GAIN
 vs
 FREQUENCY

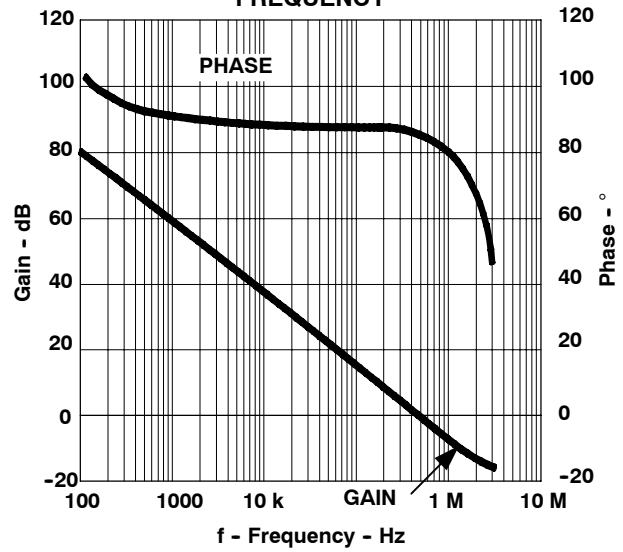

Figure 6

OSCILLATOR FREQUENCY
 vs
 LIMIT SET RESISTANCE AND
 TIMING CAPACITANCE

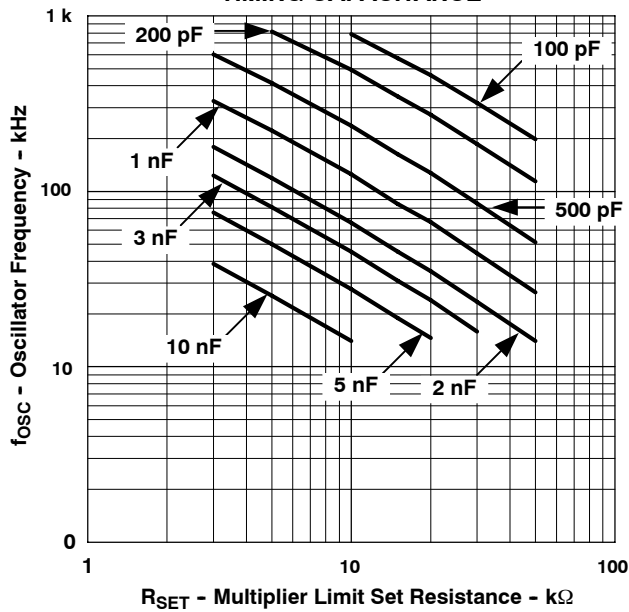

Figure 7

IMPORTANT NOTICE

Texas Instruments Incorporated and its subsidiaries (TI) reserve the right to make corrections, modifications, enhancements, improvements, and other changes to its products and services at any time and to discontinue any product or service without notice. Customers should obtain the latest relevant information before placing orders and should verify that such information is current and complete. All products are sold subject to TI's terms and conditions of sale supplied at the time of order acknowledgment.

TI warrants performance of its hardware products to the specifications applicable at the time of sale in accordance with TI's standard warranty. Testing and other quality control techniques are used to the extent TI deems necessary to support this warranty. Except where mandated by government requirements, testing of all parameters of each product is not necessarily performed.

TI assumes no liability for applications assistance or customer product design. Customers are responsible for their products and applications using TI components. To minimize the risks associated with customer products and applications, customers should provide adequate design and operating safeguards.

TI does not warrant or represent that any license, either express or implied, is granted under any TI patent right, copyright, mask work right, or other TI intellectual property right relating to any combination, machine, or process in which TI products or services are used. Information published by TI regarding third-party products or services does not constitute a license from TI to use such products or services or a warranty or endorsement thereof. Use of such information may require a license from a third party under the patents or other intellectual property of the third party, or a license from TI under the patents or other intellectual property of TI.

Reproduction of information in TI data books or data sheets is permissible only if reproduction is without alteration and is accompanied by all associated warranties, conditions, limitations, and notices. Reproduction of this information with alteration is an unfair and deceptive business practice. TI is not responsible or liable for such altered documentation.

Resale of TI products or services with statements different from or beyond the parameters stated by TI for that product or service voids all express and any implied warranties for the associated TI product or service and is an unfair and deceptive business practice. TI is not responsible or liable for any such statements.

Following are URLs where you can obtain information on other Texas Instruments products and application solutions:

Products

Amplifiers	amplifier.ti.com
Data Converters	dataconverter.ti.com
DSP	dsp.ti.com
Interface	interface.ti.com
Logic	logic.ti.com
Power Mgmt	power.ti.com
Microcontrollers	microcontroller.ti.com
Low Power Wireless	www.ti.com/lpw

Applications

Audio	www.ti.com/audio
Automotive	www.ti.com/automotive
Broadband	www.ti.com/broadband
Digital Control	www.ti.com/digitalcontrol
Military	www.ti.com/military
Optical Networking	www.ti.com/opticalnetwork
Security	www.ti.com/security
Telephony	www.ti.com/telephony
Video & Imaging	www.ti.com/video
Wireless	www.ti.com/wireless

Mailing Address: Texas Instruments
Post Office Box 655303 Dallas, Texas 75265